

BAT54ALT1

Preferred Device

Schottky Barrier Diodes

These Schottky barrier diodes are designed for high speed switching applications, circuit protection, and voltage clamping. Extremely low forward voltage reduces conduction loss. Miniature surface mount package is excellent for hand held and portable applications where space is limited.

Features

- Extremely Fast Switching Speed
- Low Forward Voltage – 0.35 V (Typ) @ $I_F = 10 \text{ mA}$
- Pb-Free Packages are Available

MAXIMUM RATINGS ($T_J = 125^\circ\text{C}$ unless otherwise noted)

Rating	Symbol	Value	Unit
Reverse Voltage	V_R	30	V
Forward Power Dissipation @ $T_A = 25^\circ\text{C}$ Derate above 25°C	P_F	225 1.8	mW mW/ $^\circ\text{C}$
Forward Current (DC)	I_F	200 Max	mA
Junction Temperature	T_J	-55 to 125	$^\circ\text{C}$
Storage Temperature Range	T_{stg}	-55 to +150	$^\circ\text{C}$

Maximum ratings are those values beyond which device damage can occur. Maximum ratings applied to the device are individual stress limit values (not normal operating conditions) and are not valid simultaneously. If these limits are exceeded, device functional operation is not implied, damage may occur and reliability may be affected.



ON Semiconductor®

<http://onsemi.com>

30 VOLT SCHOTTKY BARRIER DETECTOR AND SWITCHING DIODES

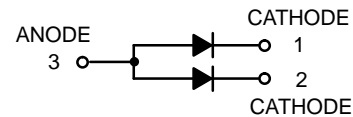

MARKING DIAGRAM

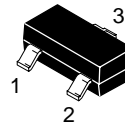

SOT-23
CASE 318
STYLE 12

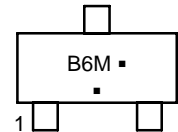

B6 = Device Code
M = Date Code*
▪ = Pb-Free Package

(Note: Microdot may be in either location)

*Date Code orientation and/or overbar may vary depending upon manufacturing location.

ORDERING INFORMATION

Device	Package	Shipping†
BAT54ALT1	SOT-23	3000/Tape & Reel
BAT54ALT1G	SOT-23 (Pb-Free)	3000/Tape & Reel
BAT54ALT3	SOT-23	10,000/Tape & Reel
BAT54ALT3G	SOT-23 (Pb-Free)	10,000/Tape & Reel

†For information on tape and reel specifications, including part orientation and tape sizes, please refer to our Tape and Reel Packaging Specifications Brochure, BRD8011/D.

Preferred devices are recommended choices for future use and best overall value.

BAT54ALT1

ELECTRICAL CHARACTERISTICS ($T_A = 25^\circ\text{C}$ unless otherwise noted) (EACH DIODE)

Characteristic	Symbol	Min	Typ	Max	Unit
Reverse Breakdown Voltage ($I_R = 10 \mu\text{A}$)	$V_{(BR)R}$	30	–	–	V
Total Capacitance ($V_R = 1.0 \text{ V}$, $f = 1.0 \text{ MHz}$)	C_T	–	7.6	10	pF
Reverse Leakage ($V_R = 25 \text{ V}$)	I_R	–	0.5	2.0	μA_{dc}
Forward Voltage ($I_F = 0.1 \text{ mA}_{dc}$)	V_F	–	0.22	0.24	V _{dc}
Forward Voltage ($I_F = 30 \text{ mA}_{dc}$)	V_F	–	0.41	0.5	V _{dc}
Forward Voltage ($I_F = 100 \text{ mA}_{dc}$)	V_F	–	0.52	0.8	V _{dc}
Reverse Recovery Time ($I_F = I_R = 10 \text{ mA}_{dc}$, $I_{R(REC)} = 1.0 \text{ mA}_{dc}$, Figure 1)	t_{rr}	–	–	5.0	ns
Forward Voltage ($I_F = 1.0 \text{ mA}_{dc}$)	V_F	–	0.29	0.32	V _{dc}
Forward Voltage ($I_F = 10 \text{ mA}_{dc}$)	V_F	–	0.35	0.40	V _{dc}
Forward Current (DC)	I_F	–	–	200	mA_{dc}
Repetitive Peak Forward Current	I_{FRM}	–	–	300	mA_{dc}
Non–Repetitive Peak Forward Current ($t < 1.0 \text{ s}$)	I_{FSM}	–	–	600	mA_{dc}

BAT54ALT1

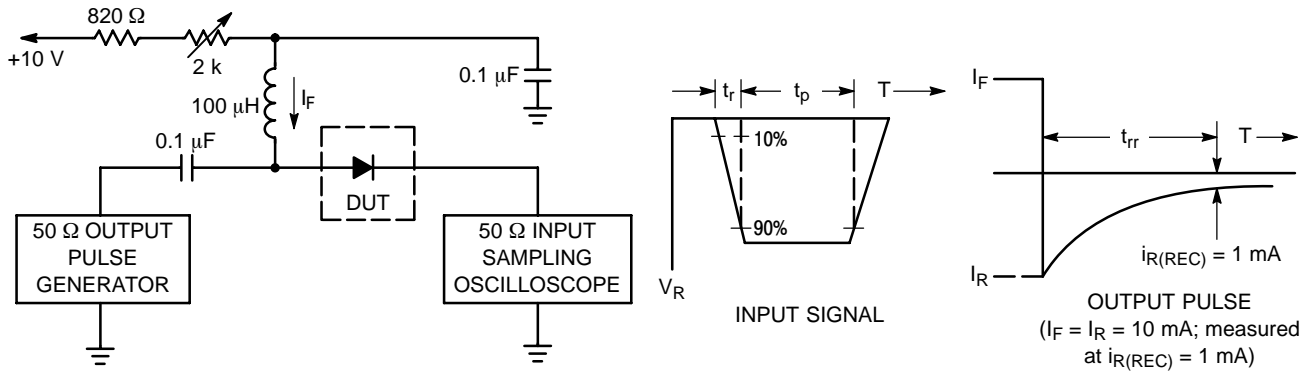

- Notes: 1. A 2.0 kΩ variable resistor adjusted for a Forward Current (I_F) of 10 mA.
 2. Input pulse is adjusted so $I_{R(\text{peak})}$ is equal to 10 mA.
 3. $t_p \gg t_{rr}$

Figure 1. Recovery Time Equivalent Test Circuit

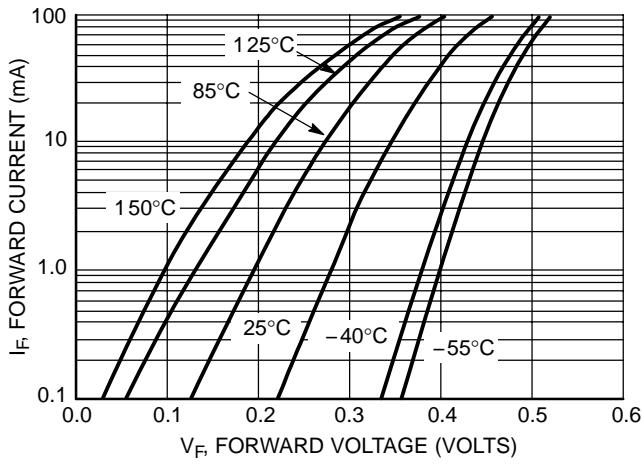

Figure 2. Forward Voltage

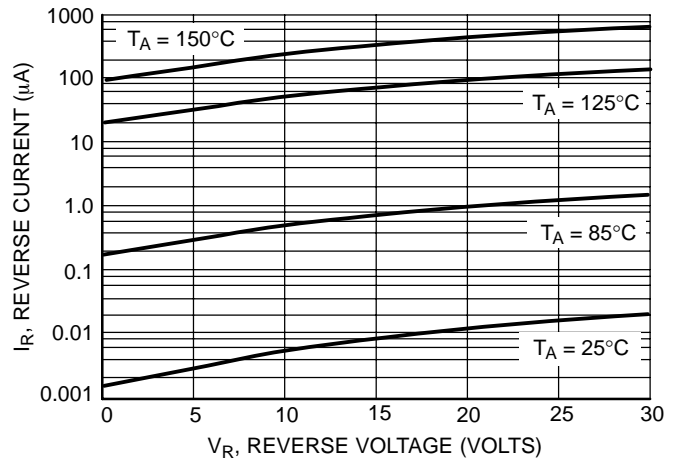

Figure 3. Leakage Current

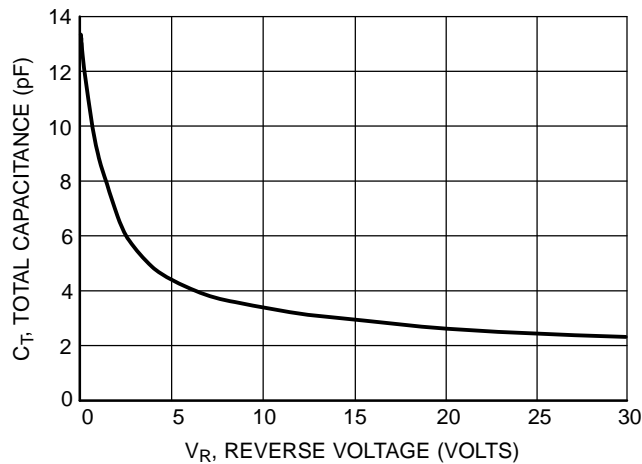
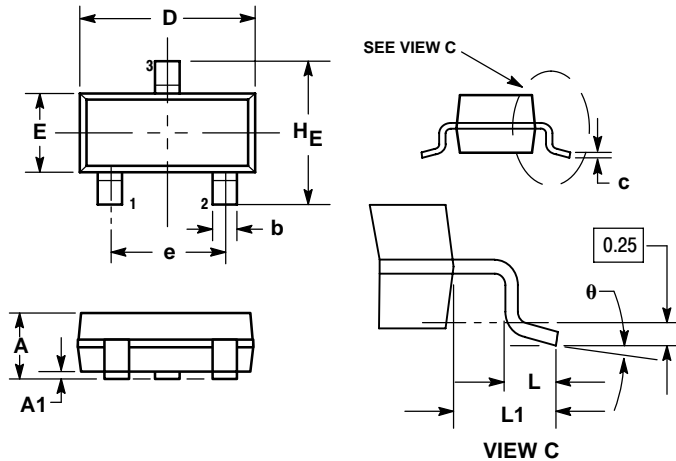

Figure 4. Total Capacitance

BAT54ALT1

PACKAGE DIMENSIONS

SOT-23 (TO-236)
CASE 318-08
ISSUE AN



- NOTES:
1. DIMENSIONING AND TOLERANCING PER ANSI Y14.5M, 1982.
 2. CONTROLLING DIMENSION: INCH.
 3. MAXIMUM LEAD THICKNESS INCLUDES LEAD FINISH THICKNESS. MINIMUM LEAD THICKNESS IS THE MINIMUM THICKNESS OF BASE MATERIAL.
 4. 318-01 THRU -07 AND -09 OBSOLETE, NEW STANDARD 318-08.

DIM	MILLIMETERS			INCHES		
	MIN	NOM	MAX	MIN	NOM	MAX
A	0.89	1.00	1.11	0.035	0.040	0.044
A1	0.01	0.06	0.10	0.001	0.002	0.004
b	0.37	0.44	0.50	0.015	0.018	0.020
c	0.09	0.13	0.18	0.003	0.005	0.007
D	2.80	2.90	3.04	0.110	0.114	0.120
E	1.20	1.30	1.40	0.047	0.051	0.055
e	1.78	1.90	2.04	0.070	0.075	0.081
L	0.10	0.20	0.30	0.004	0.008	0.012
L1	0.35	0.54	0.69	0.014	0.021	0.029
HE	2.10	2.40	2.64	0.083	0.094	0.104

STYLE 12:
PIN 1. CATHODE
2. CATHODE
3. ANODE

SOLDERING FOOTPRINT*

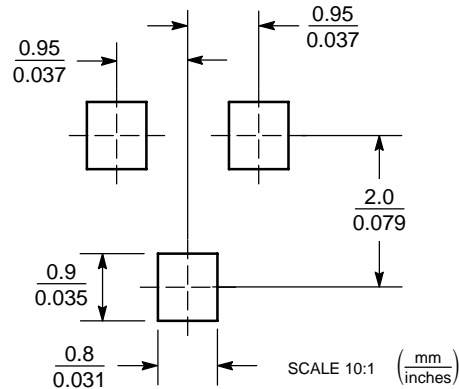

*For additional information on our Pb-Free strategy and soldering details, please download the ON Semiconductor Soldering and Mounting Techniques Reference Manual, SOLDERRM/D.

ON Semiconductor and are registered trademarks of Semiconductor Components Industries, LLC (SCILLC). SCILLC reserves the right to make changes without further notice to any products herein. SCILLC makes no warranty, representation or guarantee regarding the suitability of its products for any particular purpose, nor does SCILLC assume any liability arising out of the application or use of any product or circuit, and specifically disclaims any and all liability, including without limitation special, consequential or incidental damages. "Typical" parameters which may be provided in SCILLC data sheets and/or specifications can and do vary in different applications and actual performance may vary over time. All operating parameters, including "Typicals" must be validated for each customer application by customer's technical experts. SCILLC does not convey any license under its patent rights nor the rights of others. SCILLC products are not designed, intended, or authorized for use as components in systems intended for surgical implant into the body, or other applications intended to support or sustain life, or for any other application in which the failure of the SCILLC product could create a situation where personal injury or death may occur. Should Buyer purchase or use SCILLC products for any such unintended or unauthorized application, Buyer shall indemnify and hold SCILLC and its officers, employees, subsidiaries, affiliates, and distributors harmless against all claims, costs, damages, and expenses, and reasonable attorney fees arising out of, directly or indirectly, any claim of personal injury or death associated with such unintended or unauthorized use, even if such claim alleges that SCILLC was negligent regarding the design or manufacture of the part. SCILLC is an Equal Opportunity/Affirmative Action Employer. This literature is subject to all applicable copyright laws and is not for resale in any manner.

PUBLICATION ORDERING INFORMATION

LITERATURE FULFILLMENT:
Literature Distribution Center for ON Semiconductor
P.O. Box 61312, Phoenix, Arizona 85082-1312 USA
Phone: 480-829-7710 or 800-344-3860 Toll Free USA/Canada
Fax: 480-829-7709 or 800-344-3867 Toll Free USA/Canada
Email: orderlit@onsemi.com

N. American Technical Support: 800-282-9855 Toll Free
USA/Canada

Japan: ON Semiconductor, Japan Customer Focus Center
2-9-1 Kamimeguro, Meguro-ku, Tokyo, Japan 153-0051
Phone: 81-3-5773-3850

ON Semiconductor Website: <http://onsemi.com>

Order Literature: <http://www.onsemi.com/litorder>

For additional information, please contact your local Sales Representative.